



Clean Foot



USER MANUAL

☎ +44 20 7193 3422
✉ info@webbinfra.com
🌐 www.webbinfra.com

Clean Foot

Instructions

1. Unwarp the cover and install the U-handle by inserting four screws as illustrated in the figure-1.
2. Pick out one bundle of shoe cover using both hands as illustrated in the figure-2 and slip the plastic clips to the tracks on either side. (If it doesn't sit properly, adjust the width on either sides of the plastic clips)
3. Press the shoe cover bundle little ahead and hold the bundle upright to ensure the plastic clips are all inside the tracks as illustrated in figure-3.
4. Push the bundles on both the sides and insert all the shoe covers in to the tracks till the final piece, over the lock position as illustrated in figure-4.
5. Undo the rope that is holding the shoe cover and take it out as illustrated in figure-5.
6. Withdraw the cardboard as illustrated in figure-6.
7. Take off the plastic locking strips on both the sides by retaining the shoe cover in the same position with one hand and remove the plastic ring by pulling out completely of the machine with the other hand as illustrated in figure-7.
8. Push the shoe cover entirely inside as illustrated in figure-8.

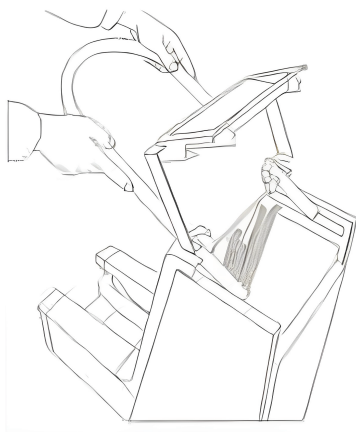

1

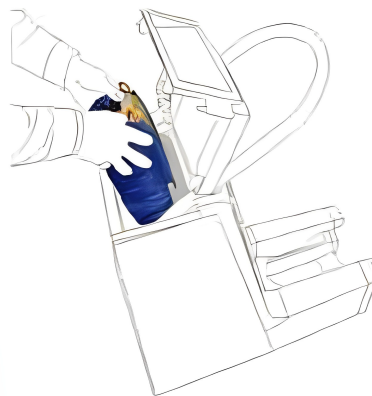

2

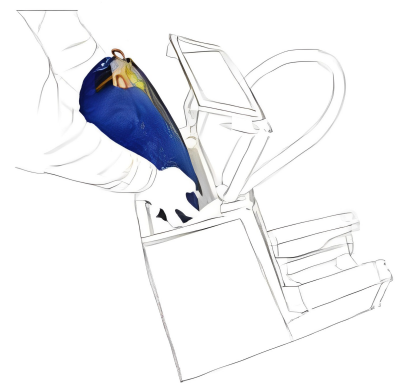

3

**Specifications are subject to change without notice based on technical recommendations and related product enhancements*

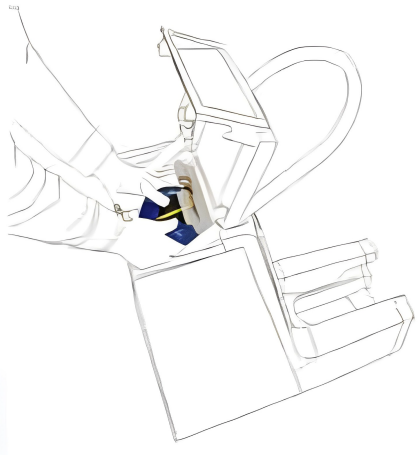

4

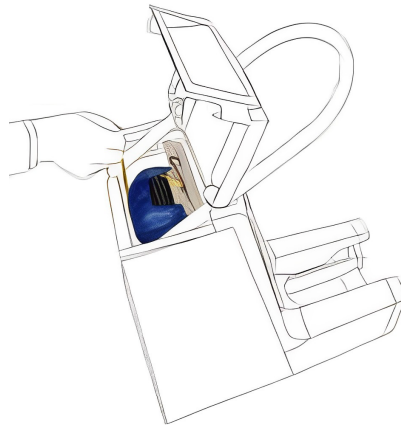

5

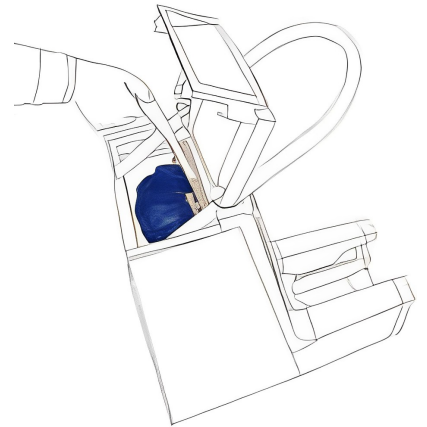

6

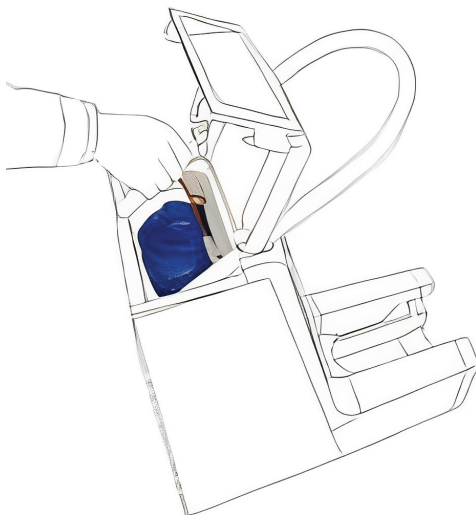

7



8

**Specifications are subject to change without notice based on technical recommendations and related product enhancements*

Choose either of the below given options based on your own priority

Option 1:

9. Take another shoe cover bundle. Repeat step 2&7.
10. Continue with Step 21.

Note: In regards to Option 1, once the first bundle of shoe covers is empty, kindly repeat step 8 and step 21 to step 23 for the second bundle.

Option 2- Merging Bundle 1 and bundle 2

11. Couple the first shoe cover of the second bundle with the last shoe cover of the first bundle.
12. Lift the last piece of the shoe cover in the first bundle as illustrated in figure-9.
13. Push down both the locks attached on the tracks to discharge the locks as illustrated in figure-10.
14. Remove the two plastic clips from the last shoe cover of the first bundle as shown in Figure 11.
15. Remove the two plastic clips from the last shoe cover of the first bundle as illustrated in figure-12
16. Take off the plastic clip from the second bundle at the right side of the plastic locking strip as illustrated in figure-13.
17. Connect the first plastic clip of the second bundle to the last shoe cover of the first bundle as illustrated in figure-14.
18. Place the first plastic clip of the second bundle inside the track and push down until the clip is fully inserted into the track, over the lock position as illustrated in figure-15.
19. Repeat step 16 and step 18 for the plastic clip of the second bundle from the left side of the plastic locking strip.
20. Repeat step 2 and step 7 for the second bundle of shoe covers.
21. Shut the cover and draw the first shoe cover outside from underneath the metal plate as illustrated in figure-16.
22. Draw the first shoe cover through the track until it has come out of the clip holder as illustrated in figure-17.
23. Clean foot is ready for use as illustrated in figure-18.

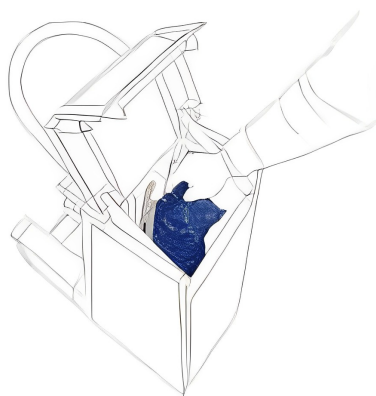

9

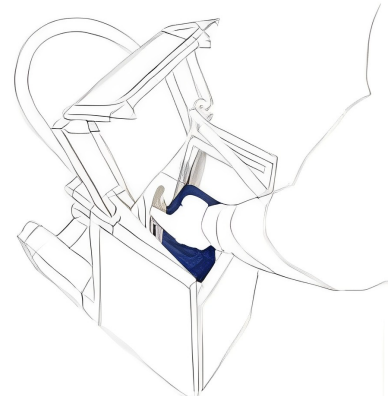

10

**Specifications are subject to change without notice based on technical recommendations and related product enhancements*

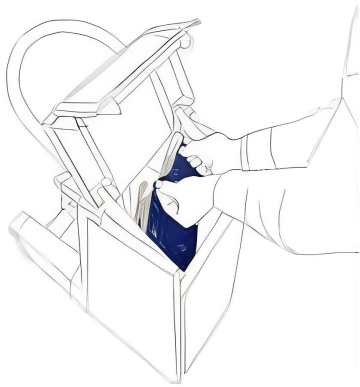

11

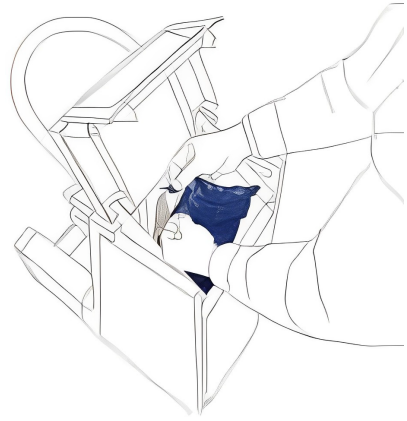

12

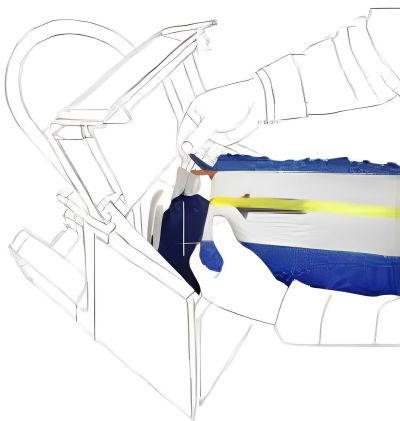

13

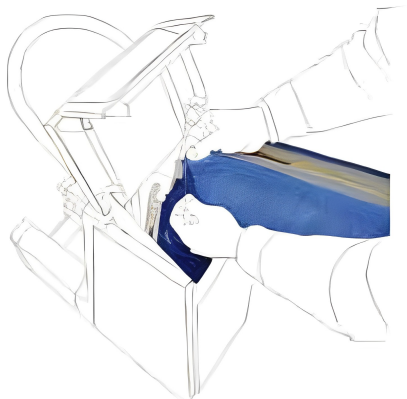

14

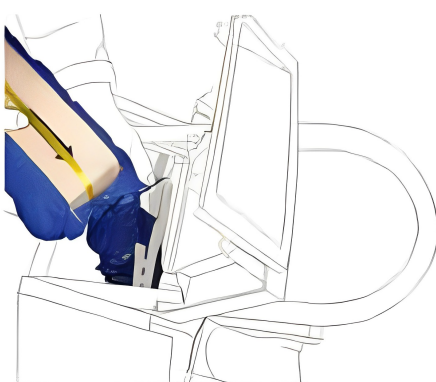

15

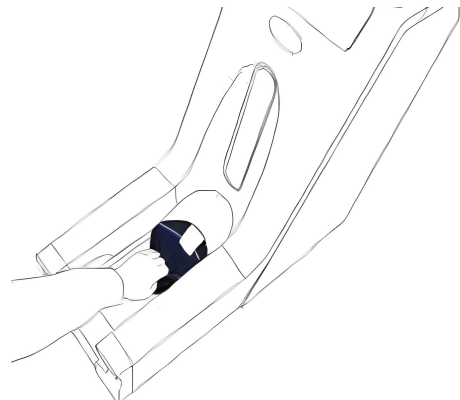

16

**Specifications are subject to change without notice based on technical recommendations and related product enhancements*

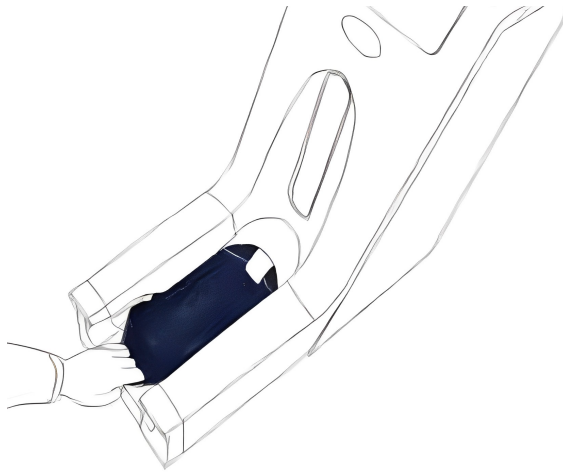

17

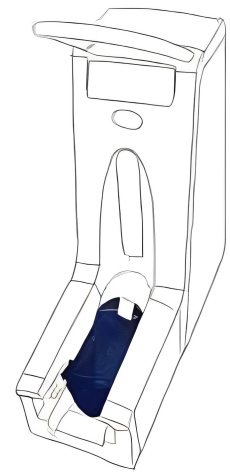

18

Most frequently occurring issues

Issue: Either one or both the sides of plastic clips are not placed inside as illustrated in figure-19.

Reason:

1. While installing shoe covers the plastic clips were not placed inside the track properly.

Solution:

1. Ensure the plastic clips are placed inside properly into the tracks as illustrated in figure-20. If not being placed properly push down both the locks attached to the tracks to relieve the locks, lift out the shoe covers and re-install them properly.

Issue: Shoe is only half placed inside the shoe cover .

Reason:

1. While pulling the shoe cover backwards, the user would have lifted his/her front foot too high resulting to the shoe cover being placed partially in the shoe as illustrated in figure-22.

Solution:

1. Place the feet inside the shoe cover and pull the shoe cover backwards in horizontal direction as illustrated in figure-23.

How to operate the Webb Clean foot

1. Place one feet inside the shoe cover as illustrated in figure-24.
2. Drag the feet backwards holding your heel in shoe cover as illustrated in figure-25.
3. Drag until the clips are released from the tracks as illustrated in figure-26.

**Specifications are subject to change without notice based on technical recommendations and related product enhancements*

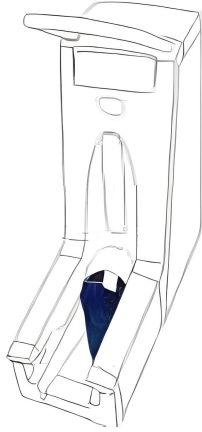

19

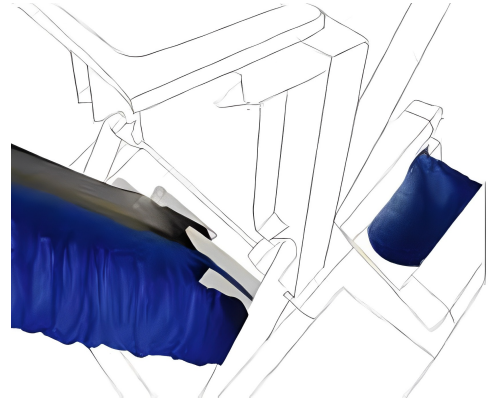

20

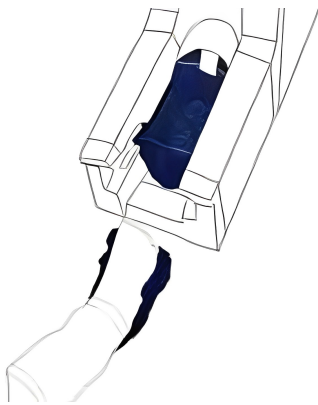

21

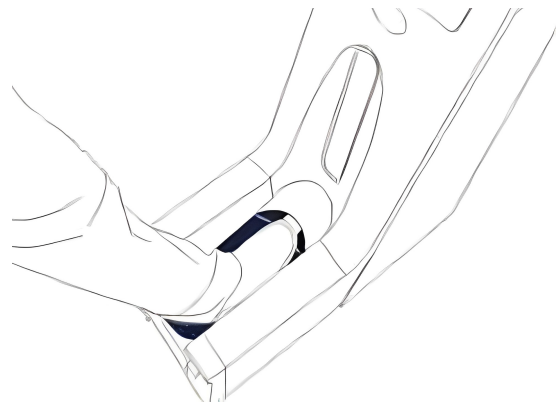

22

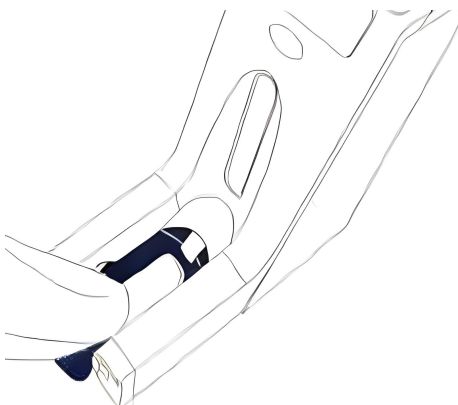

23

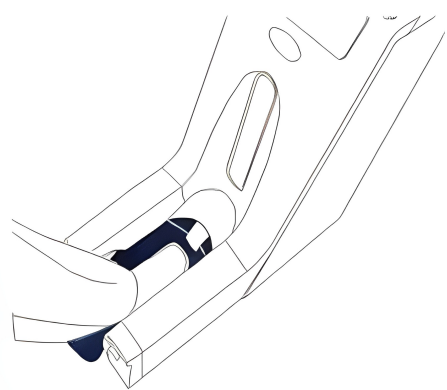

24

**Specifications are subject to change without notice based on technical recommendations and related product enhancements*

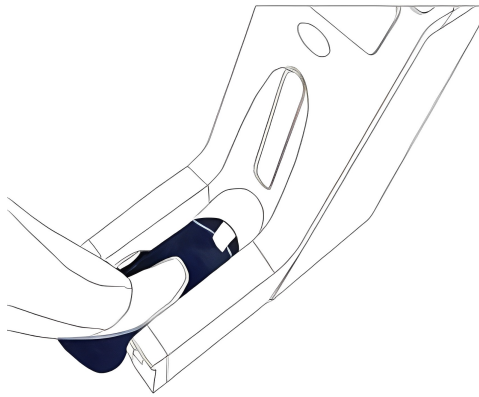

25

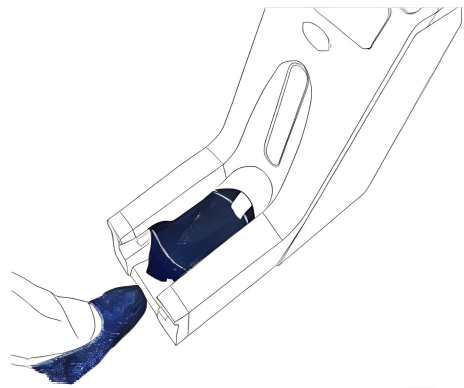

26



27

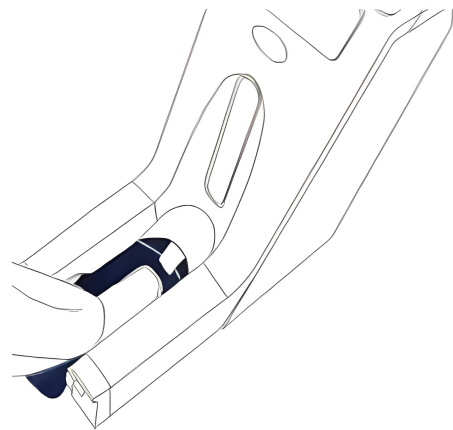

28

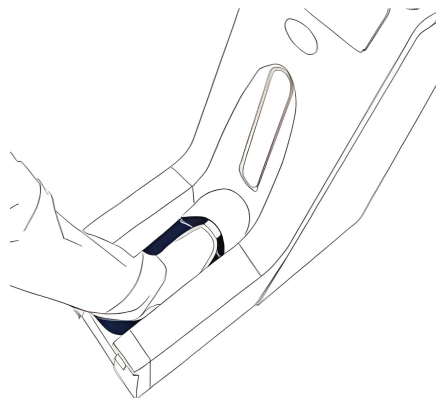

29

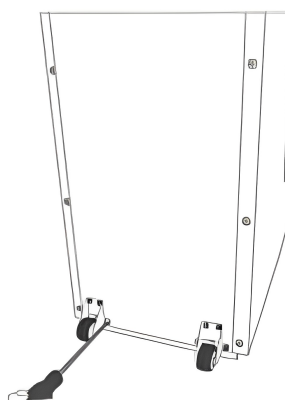

30

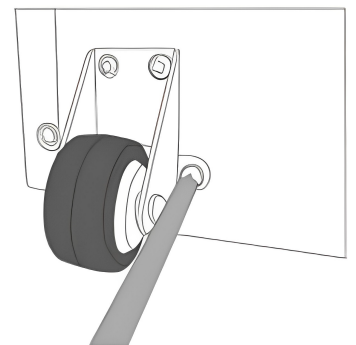

31

**Specifications are subject to change without notice based on technical recommendations and related product enhancements*



Important Notice for Shoe Covers Installation and Use

1. Ensure all plastic clips are securely inside the tracks, as illustrated in Diagram 27.
2. Insert your foot into the shoe cover, then pull the shoe cover backward horizontally, refer diagram 28.
3. Avoid lifting the front of your foot too high before it's fully inside the shoe cover, refer diagram 29

Castors Installation:

1. Install four screws for each Castor as illustrated in diagrams 30 and 31

Packing List

- Clean foot: 1 pc
- U handle: 1 pc (screws: 4 pcs)
- Castors: 2 pcs (screws:8 pcs)

**Specifications are subject to change without notice based on technical recommendations and related product enhancements*